



University of Kurdistan

Dept. of Electrical and Computer Engineering

Smart/Micro Grid Research Center

smgrc.uok.ac.ir

On robust load-frequency regulation in a restructured power system

H. Bevrani, Y. Mitani, K. Tsuji

Published (to be published) in: ***IEEE Transactions on Power and Energy***

(Expected) publication date: **2004**

Citation format for published version:

Bevrani, Hassan, Mitani, Yasunori, & Tsuji, Kiichiro (2004) On robust load-frequency regulation in a restructured power system. *IEEE Transactions on Power and Energy*, vol. 124(2), pp. 190-198.

Copyright policies:

- Download and print one copy of this material for the purpose of private study or research is permitted.
- Permission to further distributing the material for advertising or promotional purposes or use it for any profit-making activity or commercial gain, must be obtained from the main publisher.
- If you believe that this document breaches copyright please contact us at smgrc@uok.ac.ir providing details, and we will remove access to the work immediately and investigate your claim.

On Robust Load-Frequency Regulation in a Restructured Power System

Hassan Bevrani* Student Member

Yasunori Mitani** Member

Kiichiro Tsuji* Member

An approach based on structured singular value theory is proposed for the design of robust load frequency controller in response to the new technical control demand for large scale power systems in a deregulated environment. In this approach the power system is considered under the pluralistic Load Frequency Control (LFC) scheme, as a collection of different control areas. Each control area can buy electric power from some generation companies to supply the area-load. The control area is responsible to perform its own LFC by buying enough power from pre-specified generation companies, which equipped with robust load frequency controller.

A three area power system example is given to illustrate the proposed approach. The resulting controllers are shown to minimize the effect of disturbances and achieve acceptable frequency regulation in presence of uncertainties and load variation.

Keywords: load frequency control, robust control, restructured power system, structured singular value theory

1. Introduction

Currently, the electric power industry is in transition from large, vertically integrated utilities providing power at regulated rates to an industry that will incorporate competitive companies selling unbundled power at lower rates. In a deregulated environment, Load Frequency Control (LFC) acquires a fundamental role to enable power exchanges and to provide better conditions for the electricity trading. LFC is treated as an ancillary service essential for maintaining the electrical system reliability at an adequate level⁽¹⁾. There are many different schemes and organizations for the provision of ancillary services in countries with a restructured electric industry. For example in USA, Independent System Operators (ISO) are the responsible organizations⁽²⁾⁽³⁾. In Europe, the Union for the Co-ordination of Transmission of Electricity (UCTE) is responsible for setting the guidelines on overall system operation. The UCTE coordinates the operation of Transmission System Operators (TSO), which are responsible for LFC task of more than 20 countries⁽⁴⁾.

In many countries with new electric market structure, only some of generation companies equipped with secondary control requirements. For example, in Netherlands' electric industry case mid 1998, less than 60% of the total power production was under secondary control and frequency regulation⁽⁵⁾. In an open energy market, generation companies may or may not participate

in LFC task, therefore the control strategies for new structure with a few number of LFC participators are not such straight as those for vertically integrated utility structure. Technically, this problem will be more important as Independent Power Producers (IPPs) get into the electric power markets⁽²⁾.

Under restructured environment, several notable solutions have already been proposed. Ref. (2); (6), (7) have reported strategies to adapt well-tested classical LFC schemes to the changing environment of power system operation under deregulation. The H_∞ -based method for a simple area with two generation units is given in Ref. (8). Ref. (9), (10) have proposed the flexible neural network and μ -based load frequency controller for the same example. Ref. (11)~(13) discuss on the some general issues for solution of LFC problem for power system after deregulation. Ref. (14) has introduced the participation matrix concept to generalize the classic LFC scheme in a deregulated environment.

This paper focuses on technical issues associated with LFC in a restructured power system and addresses the new design of robust load frequency controller based on structured singular value theory for interconnected electric power systems with a possible structure in the competitive environment from the UCTE perspective for pluralistic LFC scheme. The power system structure is considered as a collection of control areas interconnected through high voltage transmission lines or tie-lines. Each control area has its own load frequency controller and is responsible for tracking its own load and honoring tie-line power exchange contracts with its neighbors.

We applied the proposed strategy to a three control area example. The obtained results show the designed controllers guarantee robust stability and robust

* Department of Electrical Eng., Graduate School of Eng., Osaka University
2-1, Yamada-Oka, Suita 565-0871

** Department of Electrical Eng., Kyushu Institute of Technology
1-1, Sensui-cho, Tobata-ku, Kitakyushu 804-8550

performance for a wide range of operating conditions. The preliminary steps of this work are presented in Ref. (10), (12), (15), (16).

2. Pluralistic LFC Scheme and Modeling

2.1 Genralities Depending on the electrical system structure, there are different control methods and LFC schemes, but the common objective is restoring the frequency and the net interchanges to their desired values, in each control area. For example in Europe three different types of control are defined by UCTE: Centralized network control, Decentralized pluralistic network control and Decentralized hierarchical network control⁽⁷⁾. The countries with a central electricity supply system use the central network control, where LFC is operated through a single secondary controller. The other two decentralized methods consider some separate control areas and each control area has individual controller. One or more control areas operating together for what concerns LFC can establish a control block and in this case a block co-ordinator is defined as the overall control center for the LFC and for the accounting of the whole control block.

In this paper we will focus on LFC synthesis in each control area under decentralized pluralistic network control scheme. A diagram of the pluralistic LFC is shown in Fig. 1. In this scheme all the control areas regulate their frequency by their own controllers. If some control areas perform a control block, in this case a separate controller (block coordinator) coordinates the whole block towards its neighbor blocks/control area by means of its own controller and regulating capacity.

In vertically integrated power system structure, it is assumed that each bulk generator unit is equipped with secondary control and frequency regulation requirements, but in an open energy market, generation companies may or may not participate in LFC problem. Therefore, in a control area including numerous distributed generators with an open access policy and a few LFC participators, comes the need for novel control strategies to maintain the reliability and eliminates the frequency error. Following, we introduce the independent robust

decentralized controller synthesis for each control area under the new structure.

2.2 Control Area Modeling

Consider a general control area includes N Generator units (Gunits) that supply the area-load and assume the k th generator unit G_k can be able to generate enough power to satisfy necessary participation factor for tracking the load and performing the LFC task, and other Gunits are the main supplier for area-load. The connection of each control area to the rest of power system is considered as disturbance.

Power systems are inherently non-linear. There are different complicated and nonlinear models for power systems. For LFC, however, a simplified and linearized model is usually used. In advanced control strategies (such as the one considered in this paper), the error caused by the simplification and linearization can be considered as parameter uncertainties and unmodeled dynamics.

The following proposed control area model is mainly based on modeling approach which presented in Ref. (8), (17)~(19). To build the area system model, assume that each Gunit has one generator. The linearized dynamics of the individual generators are given by:

$$\left. \begin{aligned} \frac{2H_i}{f_0} \frac{d\Delta f_i}{dt} &= \Delta P_{Mi} - \Delta P_i - d_i - D_i \Delta f_i \\ \frac{d\Delta \delta_i}{dt} &= 2\pi \Delta f_i \end{aligned} \right\} \dots (1)$$

$(i = 1, 2, \dots, N)$

where

Δ : deviation from nominal value, H_i : constant of inertia, D_i : Damping constant, δ_i : rotor angle, f_0 : nominal frequency, P_M : turbine (mechanical) power, f_i : frequency, P_i : electrical power, d_i : disturbance (power quantity).

The generators are equipped with a speed governor. The simplest models of speed governors and turbines associated with generators are given by:

$$\left. \begin{aligned} \frac{d\Delta P_{Vi}}{dt} &= -\frac{1}{T_{Hi}} \Delta P_{Vi} + \frac{K_{Hi}}{T_{Hi}} \left(\Delta P_{refi} - \frac{1}{R_i} \Delta f_i \right) \\ \frac{d\Delta P_{Mi}}{dt} &= -\frac{1}{T_{Mi}} \Delta P_{Mi} + \frac{K_{Mi}}{T_{Mi}} \Delta P_{Vi} \end{aligned} \right\} \dots (2)$$

$(i = 1, \dots, N)$

where

P_V : steam valve power, R_i : droop characteristic, T_M and T_H : time constants of turbine and governor, K_M and K_H : gains of turbine and governor, P_{refi} : reference set-point (control input).

The individual generator models are coupled to each other via the control area system. Mathematically, the local state space of each individual generator must be extended to include the system coupling variable (δ), which allows the dynamics at one point on the system transmitted to all other points.

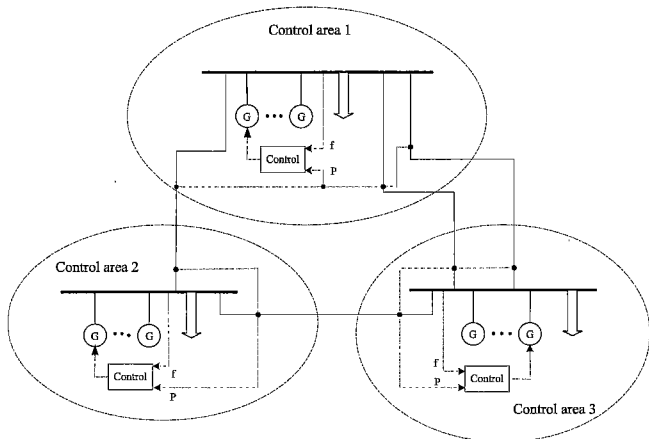

Fig.1. Three control area in pluralistic LFC scheme

Let bus m be the load bus, $V_i = |V_i| \angle \delta_i$ be the voltage at bus i and assume $\Delta \delta_{ij} = \Delta \delta_i - \Delta \delta_j$. The power flows from the Gunits to the area-load are expressed in terms of the voltages and line reactances.

$$\Delta P_i = T_i(\Delta \delta_i - \Delta \delta_m) = -T_i \Delta \delta_{ki} + T_i \Delta \delta_{km} \quad (i = 1, 2, \dots, k-1, k+1, \dots, N) \dots (3)$$

and

$$\Delta P_k = T_k(\Delta \delta_k - \Delta \delta_m) = T_k \Delta \delta_{km} \dots (4)$$

where

$$T_i = \frac{|V_i||V_m| \cos(\delta_i^0 - \delta_m^0)}{x_i} \quad (i = 1, 2, \dots, N) \dots (5)$$

T_i is synchronizing power coefficient of line i connected to the load bus (bus m) via a line whose reactance is x_i . The change in load is expressed by:

$$\Delta P_L = \sum_{i=1}^N \Delta P_i = \left(\sum_{i=1}^N T_i \right) \Delta \delta_{km} - \sum_{\substack{i=1 \\ i \neq k}}^N T_i \Delta \delta_{ki} \dots (6)$$

$\Delta \delta_{km}$ is eliminated from Eqs. (3), (4) using Eq. (6):

$$\Delta \delta_{km} = \left(\sum_{i=1}^N T_i \right)^{-1} \left[\Delta P_L + \sum_{\substack{i=1 \\ i \neq k}}^N (T_i \Delta \delta_{ki}) \right] \dots (7)$$

And rewrite the Eqs. (3), (4) using Eq. (7), as follows:

$$\Delta P_i = T_i \left(\sum_{j=1}^N T_j \right)^{-1} \left[\Delta P_L + \sum_{\substack{j=1 \\ j \neq k}}^N (T_j \Delta \delta_{kj}) \right] - T_i \Delta \delta_{mi} \quad (i = 1, 2, \dots, k-1, k+1, \dots, N) \dots (8)$$

$$\Delta P_k = T_k \left(\sum_{i=1}^N T_i \right)^{-1} \left[\Delta P_L + \sum_{\substack{i=1 \\ i \neq k}}^N (T_i \Delta \delta_{ki}) \right] \dots (9)$$

Rewriting Eqs.(1), (2) with Eqs.(8), (9), we get the state space model of control area as

$$\dot{x} = Ax + Bu + Fw \dots (10)$$

where:

$$x^T = [X_1 \ X_2 \ \dots \ X_N \ X_{N+1}], \quad w^T = [\Delta P_L \ d];$$

$$u = \Delta P_{ref_k}$$

d is the disturbance vector and,

$$X_i = [\Delta f_i \ \Delta P_{Mi} \ \Delta P_{Vi}] \quad (i = 1, 2, \dots, N)$$

$$X_{N+1} = [\Delta \delta_{k1} \ \Delta \delta_{k2} \ \dots \ \Delta \delta_{k(k-1)} \ \Delta \delta_{k(k+1)} \ \dots \ \Delta \delta_{kN} \ \Delta \delta_k]_{1 \times N}$$

Since one of objectives of LFC problem is to guarantee that the frequency will return to its nominal value following a step disturbance; hence the equation (10) is augmented to include the rotor angle of G_k , ($\Delta \delta_k$) in the state vector. To perform the above model, all the required parameters and data should be estimated or available at each control area.

3. Synthesis Methodology

The objective is to formulate the LFC problem in each control area based on structured singular value method, independently. The general scheme of proposed control system for a given area is shown in Fig. 2.

β_i and λP_i are properly setup coefficient of the secondary regulator. The robust controller acts to maintain area frequency and total exchange power close to the scheduled value by sending a corrective signal to the assigned Gunits. This signal, weighted by the generator participation factor C_{ij} , is used to modify the set points of generators. As there are many Gunits in each area, the control signal has to be distributed among them in proportion to their participation in the LFC. Hence, the generator participation factor shows the sharing rate of each participant generator unit in the LFC task. Note that for a given control area i with N Gunits,

$$\sum_{j=1}^N C_{ij} = 1 \dots (11)$$

Analogously to the traditional area control error, let define the output system variable as follows:

$$y = Cx + Ew \dots (12)$$

where

$$C = [C_1 \ C_2 \ \dots \ C_N \ C_{N+1}], \quad E = [1 \ \theta]$$

and,

$$C_i = [\beta_i \ 0 \ 0], \quad C_{N+1} = [1]_{1 \times N} \quad (i = 1, 2, \dots, N)$$

θ is a zero vector with the same size as d . To achieve our objectives and according to structured singular value theory (μ -synthesis) requirements we have proposed the control strategy applicable for each control area as shown in Fig. 3. It is notable that in model of power system there are several uncertainties because of parameter variations, model linearization and unmodeled dynamics due to some approximations. Usually, the uncertainties in power system can be modeled as multiplicative and/or additive uncertainties⁽²⁰⁾. In Fig. 3 the Δ_U models the structured uncertainty set in the form of multiplicative type and W_U include the associated weighting functions.

According to requirement performance and practical constraint on control action, three fictitious uncertainties W_{P1} , W_{P2} and W_{P3} are added to power system model. The W_{P1} on the control input sets a limit on

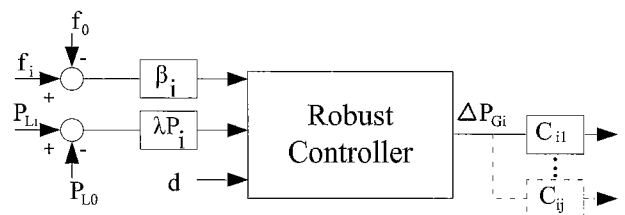

Fig. 2. General scheme of proposed control system

the allowed control signal to penalize fast change and large overshoot in the control action. This is necessary in order to guarantee implement ability of the resulting controller. The weights W_{P2} and W_{P3} at the output set the performance goal e.t. tracking/regulation on the output area control signal. Δ_P is a diagonal matrix includes the uncertainty blocks Δ_{p1} , Δ_{p2} and Δ_{p3} associated with W_{P1} , W_{P2} and W_{P3} , respectively.

We can redraw the Fig. 3 as a standard $M-\Delta$ configuration, which is shown in Fig. 4. G includes the nominal model of area power system, associated weighting functions and scaling factors. The block labeled M , consists of G and controller K . Now, the synthesis problem is designing the robust controller K . Based on the μ -synthesis, the robust stability and performance holds for a given $M-\Delta$ configuration, if and only if

$$\inf_K \sup_{\omega \in R} \mu[M(j\omega)] < 1 \dots \dots \dots (13)$$

Using the performance robustness condition and the well-known upper bound for μ , the robust synthesis problem reduces to determine

$$\min_K \inf_D \sup_{\omega} \bar{\sigma}(DM(j\omega)D^{-1}),$$

or equivalently

$$\min_{K,D} \|DM(G,K)(j\omega)D^{-1}\|_{\infty},$$

by iteratively solving for D and K (D - K iteration algorithm). Here D is any positive definite symmetric matrix with appropriate dimension and $\bar{\sigma}(\cdot)$ denotes the maximum singular value of a matrix.

The proposed strategy guarantees the robust performance and robust stability for closed-loop system. In

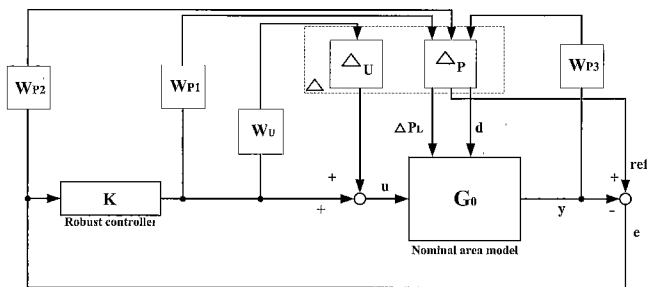

Fig. 3. The area controller synthesis framework

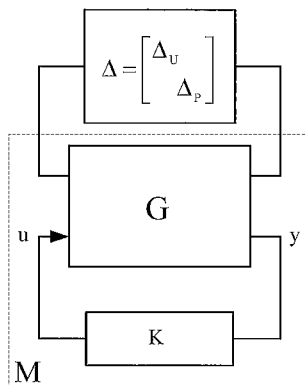

Fig. 4. $M-\Delta$ configuration

summary, the proposed method for each control area consists of the following steps:

[Step 1] Identify the uncertainty blocks and associated weighting functions for the given control area, according to dynamic model, practical limits and performance requirements, as shown in Fig. 3.

[Step 2] Isolate the uncertainties from nominal control area model, generate Δ_{p1} , Δ_{p2} , Δ_{p3} and Δ_U blocks; and performing $M-\Delta$ feedback configuration (formulate the robust stability and performance).

[Step 3] Start the D - K iteration using μ -synthesis toolbox to obtain the optimal controller.

[Step 4] Reduce the order of result controller by utilizing the standard model reduction techniques and apply μ -analysis to closed loop system with reduced controller to check whether or not upper bound of μ remains less than one.

4. Applied to a 3-Control Area

A sample power system with three control area and the related general control systems under pluralistic LFC scheme are shown in Fig. 5. Each control area has some Gunits with different parameters and it is assumed that one generator unit with enough capacity is responsible to area load frequency regulation, for example for areas 1 and 3:

$$\left. \begin{matrix} C_{i1} = 1, \\ C_{ij} = 0, \quad (j \neq 1) \end{matrix} \right\} (i = 1, 2, 3) \dots \dots \dots (14)$$

A control area may have a contract with a Gunit in other control area. For example, control area 3 buys power from G11 in control area 1 to supply its load. The power system data is given in Appendix. Following, we will discuss on application of proposed strategy in each area. The synthesis procedure in control area 1 will be described in details, and for other two areas, we will present the final results, only.

According to (10), the state space model of control area 1 will be obtained as

$$\dot{x} = Ax + Bu + Fw \dots \dots \dots (15)$$

where

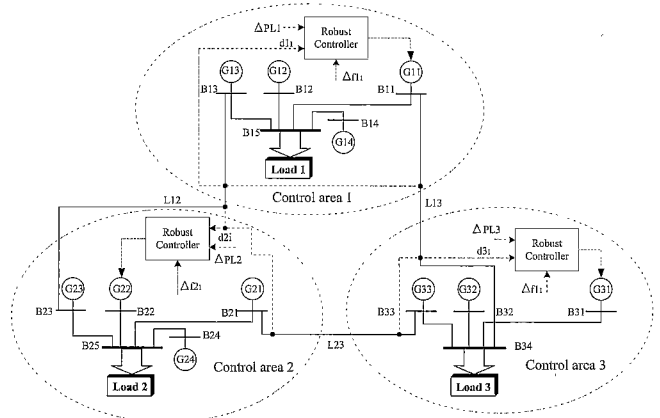

Fig. 5. Three control area power system

$$\begin{aligned}
 x^T &= [X_1 \ X_2 \ X_3 \ X_4 \ X_5] \\
 X_i &= [\Delta f_i \ \Delta P_{Mi} \ \Delta P_{Vi}] \quad (i = 1, \dots, 4) \\
 X_5 &= [\Delta \delta_{12} \ \Delta \delta_{13} \ \Delta \delta_{14} \ \Delta \delta_1]
 \end{aligned}$$

4.1 Design Objectives The control area 1 delivers enough power from G_{11} and firm power from other Gunits to supply its load and support the LFC task. In case of a load disturbance, G_{11} must adjust its output accordingly to track the load changes and maintain the energy balance.

The nominal open loop system is stable with one oscillation mode. Simulation results show that the open-loop system performance is affected by individually changes of H_1 and H_3 , more significant than changes of other control areas parameters within a reasonable range. Eigenvalue analysis shows that the considerable change in these parameters leads the power system to instability situation. Therefore, here in viewpoint of uncertainty, our focus will be concentrated on variation of H_1 and H_3 parameters which are the sources of uncertainty associated with control area model and important parameters from control issue.

Following, we will model this uncertainties as an unstructured multiplicative uncertainty block that contains all the information available about H_1 and H_3 variations. It is notable that we are not under obligation to consider the uncertainty in the few parameters, only. Considering the more complete model by including additional uncertainties is possible and causes less conservative in synthesis. However the complexity of computations and the order of resulted controller will increase.

For the control area 1, we have set our objectives as follows:

- (1) Holding stability and robust performance in presence of 75% uncertainty for H_1 and H_3 (This variation range leads the control area system to unstable condition).
- (2) Holding stability and desired reference tracking for 10% demand load change in control area ($0 \leq \Delta P_L(\%) \leq 10$).
- (3) Minimizing the effect of step disturbance from outside area (d), through the $L12$ and $L13$.
- (4) Maintaining acceptable overshoot and settling time on area frequency deviation and power changing signals.
- (5) Set the reasonable limit on control action signal with regards to changes in speed and amplitude.

4.2 Selection of Weighting Functions

Uncertainty weight selection: As it is mentioned in previous section, we can consider the specified uncertainty in power system area as a multiplicative uncertainty (W_U) associated with nominal model $G_0(s)$. Corresponding to an uncertain parameter, let $\hat{G}(s)$ denotes the transfer function from the control input u to control output y at operating points other than nominal point. Then the multiplicative uncertainty block can be expressed as

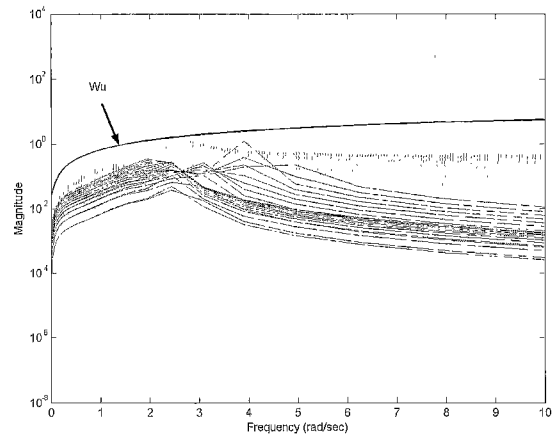

Fig.6. Uncertainty plot due to change of H_1 (dotted) and H_3 (solid)

$$\begin{aligned}
 |\Delta_U(s)W_U(s)| &= |[\hat{G}(s) - G_0(s)]G_0(s)^{-1}| \\
 &\quad (G_0(s) \neq 0). \dots\dots\dots (16)
 \end{aligned}$$

Some sample uncertainties corresponding to different values of H_1 and H_3 are shown in Fig.6. This figure shows the frequency responses of both parametric uncertainties are close to each other, hence to keep the complexity of obtained controller low, according to above result we can model uncertainties due to H_1 and H_3 variation by using a single, norm bonded, multiplicative uncertainty to cover all possible plants as follows (the frequency responses of $W_U(s)$ is also shown in Fig.6).

$$W_U(s) = \frac{-10(s + 0.04)}{s + 15} \dots\dots\dots (17)$$

This figure clearly show that attempting to cover the uncertainties at all frequencies and finding a tighter fit using higher order transfer function will result in high-order controller. The weight Eq. (17) used in our design provides a conservative design at low and high frequencies but it gives a good tradeoff between robustness and controller complexity.

Performance weight selection: As we discussed in section 3, in order to guarantee robust performance we need to add a fictitious uncertainty block Δ_P , along with the corresponding performance weights W_{P1} , W_{P2} and W_{P3} , associated with the control area error minimization and control effort to this structure. In fact an important issue in regard to selection of these weights is the degree to which they can guarantee the satisfaction of design performance objectives.

For the problem at hand a suitable set of performance weighting functions that offering a good compromise among all the conflicting time-domain specifications, is

$$\left. \begin{aligned}
 W_{p1}(s) &= \frac{0.1s}{0.01s + 1}, & W_{p2}(s) &= \frac{0.005s + 1}{35.7s + 0.04} \\
 W_{p3}(s) &= \frac{0.9s + 0.9}{100s + 1}
 \end{aligned} \right\} \dots\dots\dots (18)$$

The selection of W_{P1} , W_{P2} and W_{P3} entails a trade off among different performance requirements. The weight

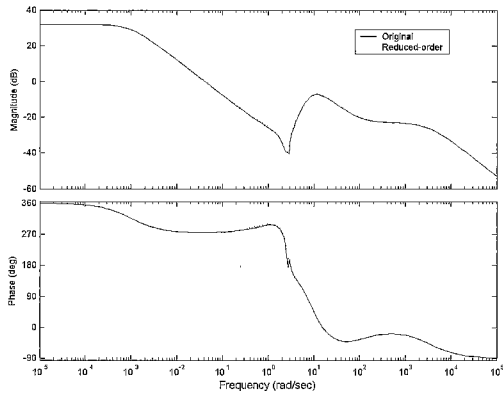

Fig. 7. Bode plots comparison of full-order (original) and the reduced-order controller

on the control input W_{P1} was chosen close to a differentiator to penalize fast change and large overshoot in the control input. The weights on input disturbance from other areas (W_{P3}) and output error (W_{P2}) were chosen close to an integrator at low frequencies in order to get disturbance rejection, good tracking and zero steady-state error. Additionally the order of the selected weights should be kept low in order to keep the controller complexity low. Finally, we know that to reject disturbances and to track command signal property, it is required that singular value of sensitivity function be reduced at low frequencies, W_{P2} and W_{P3} be such select that this condition to be satisfied.

Our next task is to isolate the uncertainties from the nominal plant model and redraw the system in the standard $M-\Delta$ configuration. By using the uncertainty description and performance weights developed in above, we get an uncertainty structure Δ with a scalar block (corresponding to the uncertainty) and a 3×3 block (corresponding to the performance). Having setup our robust synthesis problem in terms of the structured singular value theory, we used the μ -analysis and synthesis toolbox to obtain a solution.

The controller $K_1(s)$ is found at the end of the Three $D-K$ iteration yielding the value of about 0.994 on the upper bound on μ , thus guaranteeing robust performance. The resulting controller has a high order (29th). The controller is reduced to a 7th order with no performance degradation, using the standard Hankel Norm approximation. The Bode plots of the full-order controller and the reduced-order controller are shown in Fig. 7.

The transfer function of the reduced order controller is given as $K_1(s) = N_1(s)/D_1(s)$, with

$$N_1(s) = 226.28s^6 + 23024.16s^5 + 20719s^4 + 153700s^3 + 245730s^2 + 162930s + 844$$

$$D_1(s) = s^7 + 3240s^6 + 70777s^5 + 710490s^4 + 362130s^3 + 3853000s^2 + 24901s + 21$$

Using the same procedure and setting the similar objectives as discussed above, give us the desired robust load frequency controllers for control areas 2 and 3 (The corresponding polynomials are given in Appendix).

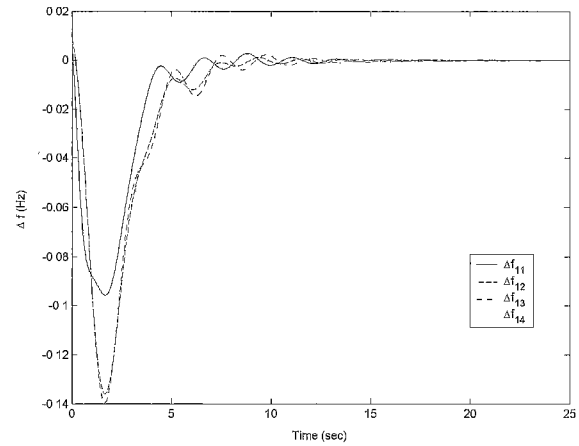

Fig. 8. Frequency deviation at Gunits in control area 1, following a 10% load increase

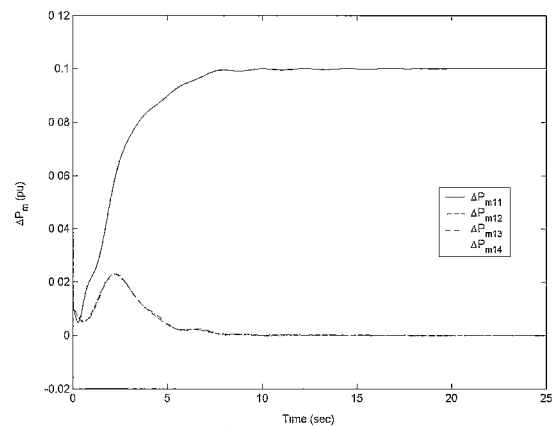

Fig. 9. Change in supplied power in control area 1, following a 10% load increase

5. Simulation Results

In order to demonstrate the effectiveness of the proposed strategy, some simulations were carried out. In these simulations, the proposed load frequency controllers were applied to the three control area power system described in Fig. 5.

Fig. 8 shows the frequency deviation in control area 1, following a 10% increase in the area-load. $\Delta f_{11}, \dots, \Delta f_{14}$ display the frequency deviation at G_{11}, \dots, G_{14} , respectively. At steady-state the frequency in each control area reaches to its nominal value.

Fig. 9 shows the changing in power coming to the control area 1 from its Gunits. It can be seen the power is initially coming from all Gunits to respond to the load increase which will result in a frequency drop that is sensed by the speed governors of all machines. But after few seconds and at steady-state the additional power is coming from G_{11} only and other Gunits do not contribute to the LFC task.

Fig. 10 demonstrates the disturbance rejection property of closed loop system. This figure shows the frequency deviation at Gunits in control area 1, following a step disturbance of 0.1 pu on areas interconnection lines $L12$ and $L13$ at $t = 17s$. Power system is started up with a 10% load increase in each area, already.

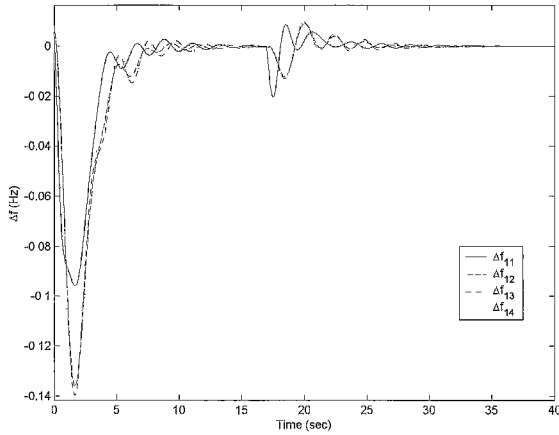
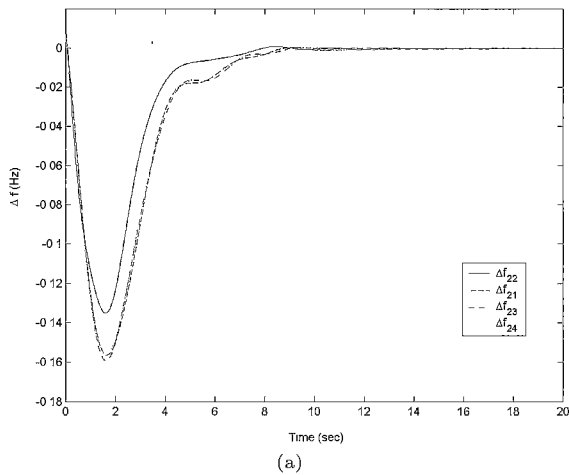
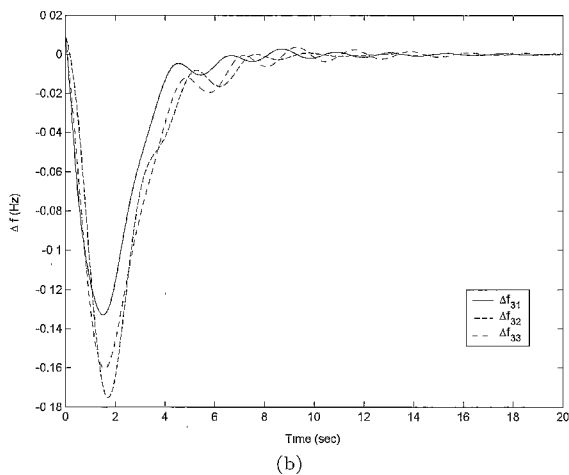

Fig. 10. Frequency deviation at Gunits in control area 1, following a 0.01 pu step disturbance on interconnection lines at $t = 17$ s and 10% load increase at $t = 0$ s



(a)



(b)

Fig. 11. Frequency deviation at Gunits in (a) control area 2, (b) control area 3, following a 10% load increase in each area

Fig. 11 shows the frequency deviation in control area 2 and 3, following a 10% load increase in each area. Fig. 12 presents the frequency deviation at Gunits and corresponding control action signals, following a large step disturbance 0.1 pu on each interconnection line (L12, L13 and L23) in presence the worst case of H_1

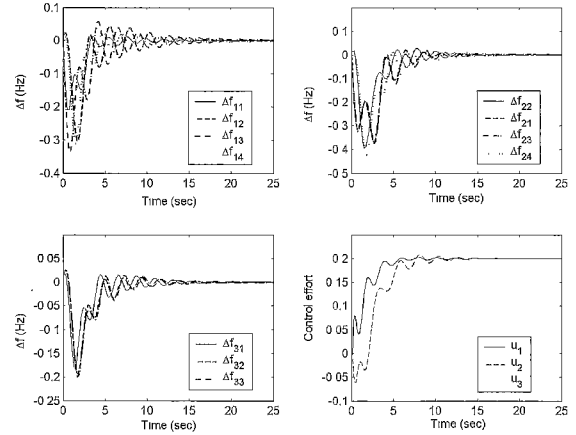

Fig. 12. Frequency deviation at Gunits in (a) control area 1, (b) control area 2, (c) control area 3, and, (d) control signals, following a step disturbance in interconnection lines and the worst case of uncertainties in each area

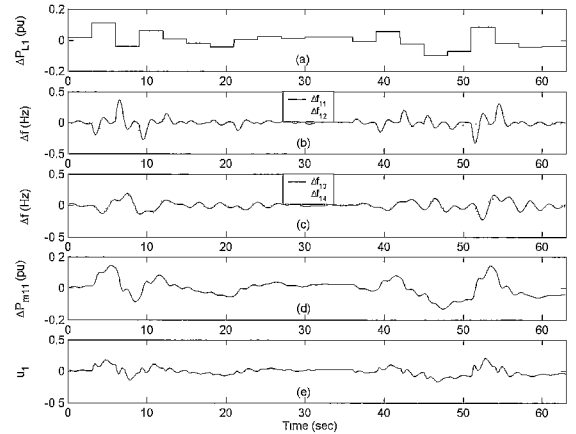

Fig. 13. System response to random demand load; (a) demand load, (b) $\Delta f_{11}, \Delta f_{12}$, (c) $\Delta f_{13}, \Delta f_{14}$, (d) power change at G_{11} , and, (e) control effort

and H_3 uncertainties in three area, simultaneously.

For the last simulation case, random demand load signal shown in Fig. 13(a), representing expected area demand load fluctuations, is applied to the control area 1. The frequency deviations at Gunits are shown in Fig. 13(b), (c). Power change and control signals are given in Fig. 13(d), (e). This figures show the controller tracks the load fluctuations effectively.

The last two figures investigate the proposed controllers guarantee the robust stability and robust performance for a wide range of operating conditions.

6. Conclusions

In this paper a new method for robust load frequency controllers using structured singular value theory in a restructured power system has been proposed. Design strategy includes enough flexibility to setting the desired level of stability and performance, and, considering the practical constraint by introducing appropriate uncertainties.

The proposed method was applied to a three control areas power system under a pluralistic LFC scheme.

Simulation results demonstrated the effectiveness of methodology. It was shown that the designed controllers guarantee the robust stability and robust performance such as precise reference frequency tracking and disturbance attenuation under a wide range of parameter variation and area-load conditions.

(Manuscript received Feb. 21, 2003,
revised July 2, 2003)

References

- (1) N. Jaleeli, D.N. Ewart, and L.H. Fink: "Understanding Automatic Generation Control", *IEEE Trans. Power Systems*, Vol.7, No.3, pp.1106–1122 (1992)
- (2) R.D. Chrítie and A. Bose: "Load Frequency Control Issues in Power System Operation after Deregulation", *IEEE Trans. Power Systems*, Vol.11, No.3, pp.1191–1200 (1996)
- (3) A.P.S. Meliopoulos, G.J. Cokkinides, and A.G. Bakirtzis: "Load Frequency Control Service in a Deregulated Environment", Proc. of 31st Int. Conf. on System Sciences, USA, pp.24–31 (1998)
- (4) UCPTE: UCPTE rules for the Co-ordination of the accounting and the organization of the Load-frequency Control, Document (1999)
- (5) B. Roffel and W.W. deBoer: "Analysis of power and frequency control requirements in view of increased decentralized production and market liberalization", Control Engineering Practice, Article in press (2002)
- (6) J. Kumar, NG. K. Hoe, and G.B. Sheble: "AGC simulator for price-based operation, Part 1: A model", *IEEE Trans. Power Systems*, Vol.2, No.12, pp.527–532 (1997)
- (7) B. Delfino, F. Fornari, and S. Massucco: "Load-frequency control and inadvertent interchange evaluation in restructured power systems", *IEE Proc.-Gener. Transm. Distrib.*, Vol.149, No.5, pp.607–614 (2002)
- (8) A. Feliachi: "Reduced H_{∞} Load Frequency Controller in a Deregulated Electric Power System Environment", Proc. of the Conference on Decision & Control, pp.3100–3101, California, USA (1997)
- (9) H. Bevrani: "A novel approach for power system load frequency controller design", Proc. of IEEE/PES T&D Asia Pacific, pp.184–189, Yokohama, Japan (2002)
- (10) H. Bevrani: "Robust Load Frequency Controller in a Deregulated Environment: A μ -synthesis Approach", Proc. of IEEE Int. Conf. on Control Applications, pp.616–621, USA (1999)
- (11) B.H. Bakken and O.S. Grande: "Automatic Generation Control in a Deregulated Power System", *IEEE Trans. Power Systems*, Vol.13, No.4, pp.1401–1406 (1998)

- (12) H. Bevrani, Y. Mitani, and K. Tsuji: "Robust Low-order Load Frequency Controller in a Deregulated Environment", Proc. of 5th Asia-Pacific Conf. on Control and Measurement (APC CM), China (2002)
- (13) H. Bevrani, A. Rezazadeh, and M. Teshnehlab: "Comparison of Existing LFC Approaches in Deregulated Environment", Proc. of 5th IEE Int. Conf. on Power System Management and Control, London, UK (2002)
- (14) V. Donde, M.A. Pai, and I.A. Hiskens: "Simulation and optimization in a AGC system after deregulation", *IEEE Trans. Power Systems*, Vol.16, No.3, pp.481–489 (2001)
- (15) H. Bevrani: "Robust Load Frequency Control in Multi-area Power Systems", Technical research report, DISP1378, West Regional Electric Co., Iran (2001)
- (16) H. Bevrani, Y. Mitani, and K. Tsuji: "Robust load frequency regulation in a new distributed generation environment", Proc. of IEEE-PES General Meeting (CD-ROM), Toronto, Canada (2003)
- (17) A. Feliachi: "On load-frequency control in a deregulated environment", Proc. of IEEE Int. Conf. on Control Applications, pp.437–441 (1996)
- (18) F. Liu, Y.H. Song, J. Ma, S. Mei, and Q. Lu: "Optimal load-frequency control in restructured power systems", *IEE Proc. Gener. Transm. Distrib.*, Vol.150, No.1, pp.87–95 (2003)
- (19) F. Liu, Y.H. Song, J. Ma, S. Mei, and Q. Lu: "Optimal frequency control in deregulated power systems", Proc. of IEEE Int. Conf. on Power System Technology, Vol.2, pp.944–948 (2002)
- (20) M. Djukanovic, M. Khammash, and V. Vittal: "Sequential Synthesis of Structured Singular Value Based Decentralized Controllers in Power Systems", *IEEE Trans. Power Systems*, Vol.14, pp.635–641 (1999)

Appendix

The polynomials associated with $K_1(s)$ and $K_2(s)$:

$$\begin{aligned}
 N_2(s) &= 145s^5 + 1445267s^4 + 178943657s^3 \\
 &\quad + 96405249s^2 + 274613248s + 323019700 \\
 D_2(s) &= s^6 + 288s^5 + 20235s^4 + 767219s^3 \\
 &\quad + 17402801s^2 + 226558154s + 226075 \\
 N_3(s) &= 226.3s^5 + 22873s^4 - 1616s^3 + 137110s^2 \\
 &\quad + 126934s + 533 \\
 D_3(s) &= s^6 + 3239.8s^5 + 68092s^4 + 638727s^3 \\
 &\quad + 3016725s^2 + 16332.2s + 13.3
 \end{aligned}$$

app. Table 1. Applied data for simulation

Quantity	G11	G12	G13	G14	G21	G22	G23	G24	G31	G32	G33
Rating (MW)	1600	600	800	800	600	1200	800	1000	1400	600	600
Constant of Inertia: $H(sec)$	5	4	4	5	4	5	4	5	5	4	4
Damping: $D(pu MW/Hz)$	0.02	0.01	0.01	0.015	0.01	0.02	0.01	0.015	0.02	0.01	0.01
Droop characteristic: $R(\%)$	4	5.2	5.2	5	5.2	4	5.2	5	4	5.2	5.2
Generator's: $T_p = 2H/f_0$	0.167	0.134	0.134	0.167	0.134	0.167	0.134	0.167	0.167	0.134	0.134
Turbine's Time Constant: T_M	0.5	0.5	0.5	0.5	0.5	0.5	0.5	0.5	0.5	0.5	0.5
Governor's Time Constant: T_H	0.2	0.1	0.15	0.1	0.1	0.2	0.15	0.1	0.2	0.1	0.1
Gains: K_M, K_H	1	1	1	1	1	1	1	1	1	1	1
Synchronizing coefficient: T_j	0.2	0.1	0.1	0.2	0.1	0.2	0.1	0.2	0.2	0.1	0.1
Sync. Coef.: $T_j (MW/rad)$	$T_{12} =$	60	$T_{13} =$	60	$T_{23} =$	100					

Hassan Bevrani (Student Member) received his M.Sc. degree (first class honors) in Electrical Engineering from K. N. Toosi University of Technology, Tehran, Iran in 1997. He is currently a Ph.D. student at Osaka University. His special fields of interest included robust control and modern control applications in Power system and Power electronic industry. He is a student member of the Institute of Electrical Engineers of Japan, IEE, and IEEE.



Yasunori Mitani (Member) received his B.Sc., M.Sc., and Dr. of Engineering degrees in electrical engineering from Osaka University, Japan in 1981, 1983, and 1986 respectively. He joined the Department of Electrical Engineering of the same university in 1990. He is currently a professor in Kyushu Institute of Technology. His research interests are in the areas of analysis and control of power systems. He is a member of the Institute of Electrical Engineers of Japan, the Institute of Systems, Control and Information Engineers of Japan, and the IEEE.



Kiichiro Tsuji (Member) received his B.Sc. and M.Sc. degrees in electrical engineering from Osaka University, Japan, in 1966 and 1968, respectively, and his Ph.D. in systems engineering from Case Western Reserve University, Cleveland, Ohio in 1973. In 1973 he joined the Department of Electrical Engineering, Osaka University, and is currently a professor at Osaka University. His research interests are in the areas of analysis, planning, and evaluation of energy systems, including electrical power systems. He is a member of the Institute of Electrical Engineers of Japan, the Japan Society of Energy and Resources, the Society of Instrument and Control Engineers, the Institute of Systems, Control and Information Engineers, and the IEEE.

